

# Spraybooth Filters

## and Related Products

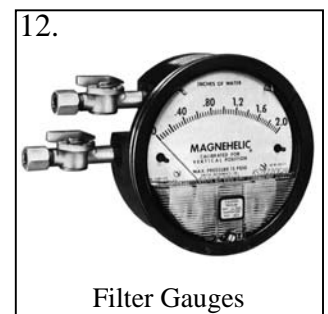
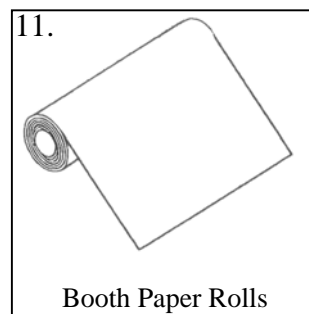
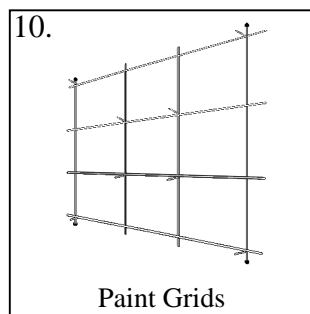
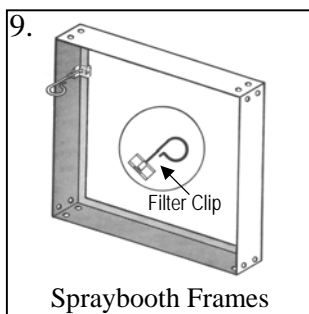
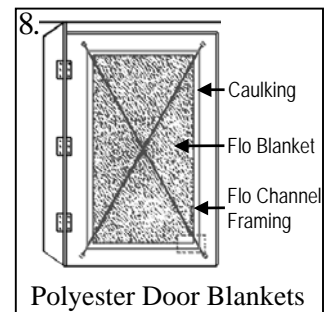
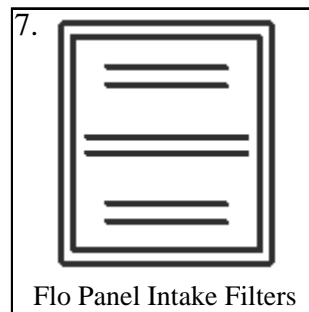
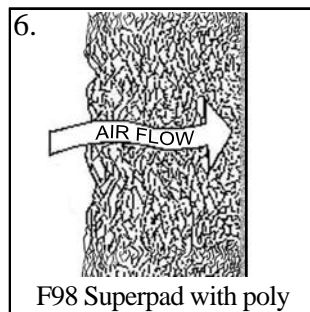
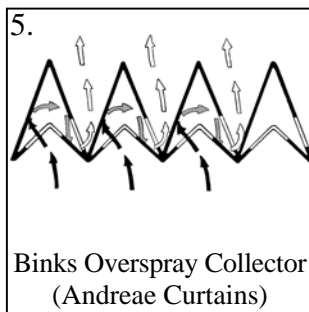
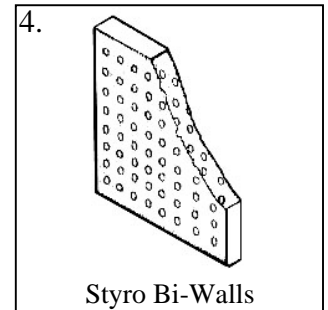
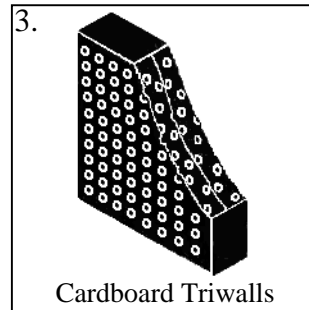
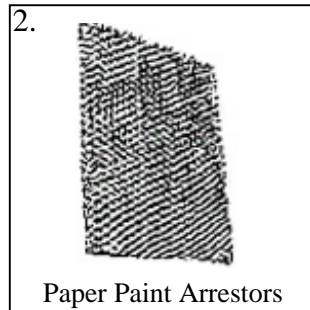
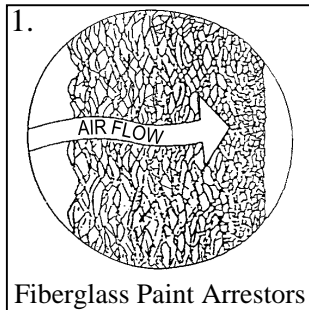

**Florence Filter Corporation** also stocks related Spraybooth Products such as • Flo Panels with lint trap  
 • Dust Catching Tackifiers • Strippable Booth Coating • Booth Door Gasketing • Holding Clips  
 • Rubber Strips to seal bottom of booth doors • Paint Strainers with mesh sizes coarse, medium or fine  
 • Reusable Perma Pad Paint Arrestors • Paint Arrestor Holding Frames • DOWNDRAFT media filters  
 • Paint Arrestor Curtains • Reusable Cubes • Dual-Pocket Bags and 99.99% efficient Bag filters.

Other Dust and Odor Control filters by FFC are: Charcoal, Pleats, Bags, Rigid Pacs, Deep Pleats, Disposables, Poly & Fiberglass Media Pads, Cooler Pads and Hepas. For other reliable filter products to control dust or odor ask our Customer Service Representative for assistance.



# Flo Guard Filters

used in  
**Powder Coating & Dust Collecting  
Operations**

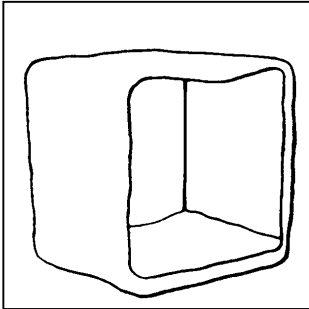

### Cube Filter

Stocked in efficiencies of 88% to 99.99%, based on 5-micron-sized particle tests. Cubes are available as elements only, elements stapled to perimeter wire or elements with perimeter wire enclosed in header frame. As a means of cost savings powder can be shaken out to be reclaimed and the cube can be reused. Standard 20"x20"x12".

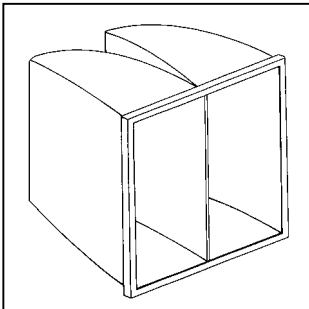

### Dual Pocket Poly Bag Filter

Stocked in efficiencies of 88% to 99.99%, based on 5-micron-sized particle tests. Available as element only, element stapled to a perimeter holding wire or element with perimeter wire and enclosing header frame. Bag can be shaken out to reclaim costly coating powder and the filter can then be reused. Standard 20"x20"x12".

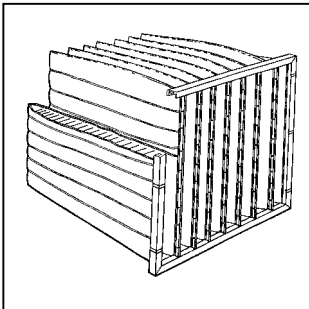

### Bag Filter

Available in efficiencies of 88% to 99.99%, based on 5-micron-sized particle tests. Bags always have header frames with optional downstream gasketing. All Bag Filters are ASHRAE tested as well on a 1.5 micron-sized particle scale. Bag can be shaken out and reused. Standard 20"x20"x15" and 20"x20"x12".

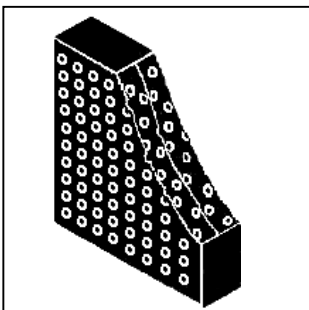

### TriWall Baffle Arrestor

Stocked in Efficiencies of 88% to 98%, based on 10-micron-sized particle tests. Available with glass or poly media in 2nd chamber as well as options of high efficiency straining material at exit side of filter. Can be shaken out and reused. Standard 20"x20"x3".



## FLORENCE FILTER CORPORATION

*"Over 35 Years of Filtration Excellence"*

530 W. Manville • Compton • California 90220  
(310) 637-1137 • FAX (310) 631-4323 • (800) 776-2021

3/11/04  
P163